



About the product

The L20, L18, and L16 Series flush doors are designed to meet the architectural requirements for full flush doors. The L14 Series flush doors are designed to meet the architectural requirements for maximum duty full flush doors. Refer to the Architectural section for specifications and the selection and usage guide of the appropriate door constructions.

This premium door construction combines the strength and dimensional stability of steel with the structural integrity of the laminate core. The continuous bonding of core to steel face sheets provides an attractive, flat door, free of face welding marks. Tests have proven that the L Series door has high resistance to impact damage, low thermal conductivity and high STC ratings.

To meet application, specification and performance requirements, the L Series door offers a wide range of specifiable options including sizes, glass light designs and hardware (mechanical, pneumatic, electrical) preparations.

L Series doors are 1-3/4" (45mm) thick.

Installation

1. Installation shall conform to the published Steelcraft installation instructions, ANSI A250.11-2001 (formerly SDI 105) *Recommended Erection Instructions for Steel Frames and HMMA 840s*.
2. Fire Rated Assemblies must be in accordance with NFPA Pamphlet 80. The *Authority Having Jurisdiction* is the final authority on issues related to the installation and use of installed Fire Rated Doors.

Features and benefits

Steelcraft's L Series doors offer the following standard unique features, which enhance long term performance and durability:

1. **Core Systems** that enhance the structural integrity of the door:
 - **Honeycomb (standard):** 1" (25mm) cell kraft honeycomb configuration that increases structural integrity while reducing overall weight
 - **Polystyrene (optional):** enhanced thermal performance
 - **Polyurethane (optional):** extreme thermal performance
2. **Full Height, Epoxy Filled Mechanical Interlock Edges** provide structural support and stability the full height of the door edges. Available edge options:
 - **Visible Edge Seam (standard):** full height, epoxy filled mechanical Interlocked edges
 - **Filled Seam:** optional edge seam epoxy filled and finished smooth. Includes tack welds above and below edge cutouts for hinges, locks, etc.
 - **Welded Edge Seam:** optional edge seam welded with 1" (25mm) long weld, 6" (51mm) on center, epoxy filled between welds and finished smooth; available on L18, L16 and L14 doors.
3. **Universal Hinge Preparations** (patented) allow for easy field conversion from standard weight .134" (3.3mm) hinges to heavy weight .180" (4.7mm) hinges.
4. **14 Gauge [0.067" (1.7mm)] Inverted Top and Bottom Channels** provide stability and protection for the top and bottom edges from abuse.
5. **Beveled Hinge and Lock Edges** allow for tighter installation tolerances, ensure easier operation and eliminate binding and sticking.
6. **Recessed Designer™ Glass Trim** provides a clean, neat and flush finish with the door surface.
7. **Factory Applied Baked-On Rust Inhibiting Primer** paint in accordance with ANSI A250.10-1998.

Specification compliance

1. Door construction for Steelcraft L Series full flush doors meets the requirements of ANSI A250.8-2003 (SDI 100).
2. Hardware preparations and reinforcements are in accordance with ANSI A250.6-2003. Locations are in accordance with ANSI/DHI A115 unless otherwise stated.

Fire ratings

L Series doors meet the broadest fire rating requirements. They are listed for installations requiring compliance to both neutral pressure testing (ASTM E152 and UL-10B) and positive pressure standards (UL-10C).

Rigid Honeycomb

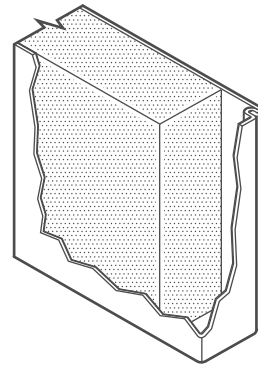
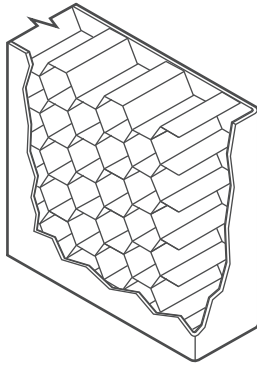

Standard Laminated Honeycomb Core

- 1" (25mm) cell, 99 pound Kraft honeycomb
- Honeycomb surfaces sanded for maximum adhesion
- Impregnated with phenolic resin (resists mildew and vermin)
- Laminated to both face sheets with contact adhesive
- Assembled door is run through high pressure pinch rollers, achieving ultimate bond

Optional Polystyrene Core

- 1 pound (453.6g) per ft³ density slab
- Laminated to both face sheets with contact adhesive
- Labeled applications

Optional Polyurethane Core

- 1.8 pound (816.5g) per ft³ density slab
- Laminated to both face sheets with contact adhesive
- Non-Labeled applications

Optional cores are polystyrene or polyurethane

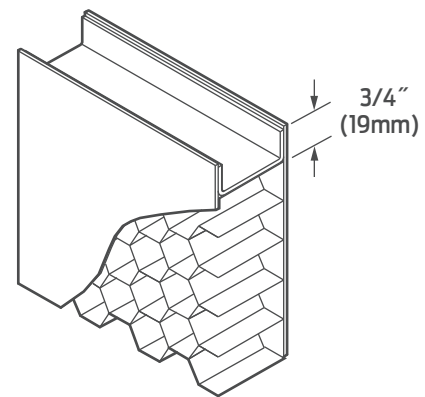
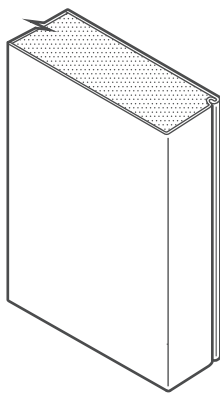

Standard Premium Edge Construction

- Beveled hinge & lock edges
- Full height mechanical interlock with epoxy adhesive
- Visible edge seam standard
- Seamless edge optional

Standard Rigid 14 Gauge End Channel Construction

- 14 gauge inverted galvanized top & bottom channels
- Projection welded to both face sheets
- Optional 24 gauge galvanized top caps

Door application and usage

Series	Steel Thickness	Opening	Usage Frequency	
L20	20 Ga (0.8mm)	Interior - Cold Rolled Steel	Standard Duty	Light Commercial applications with minimal use and abuse
L20	20 Ga (0.8mm)	Exterior - Galvanized Steel		
L18	18 Ga (1.0mm)	Interior - Cold Rolled Steel	Heavy Duty	Heavy Commercial & Institutional applications with high use
L18	18 Ga (1.0mm)	Exterior - Galvanized Steel		
L16	16 Ga (1.3mm)	Interior - Cold Rolled Steel	Extra Heavy Duty	Extra Heavy Commercial applications with potential of very high use
L16	16 Ga (1.3mm)	Exterior - Galvanized Steel		
L14	14 Ga (1.7mm)	Interior - Cold Rolled Steel	Maximum Duty	Extra Heavy Commercial applications with extremely high use
L14	14 Ga (1.7mm)	Exterior - Galvanized Steel		

Standard hardware preparations

Typical hardware applications shown. Refer to “Hardware” section for more details.

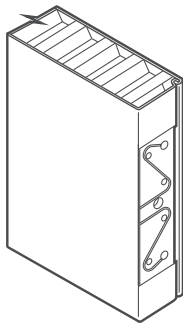

Universal Mortise Hinge Prep
7 Gauge Universal hinge reinforcement

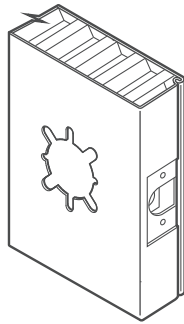

61L Lock

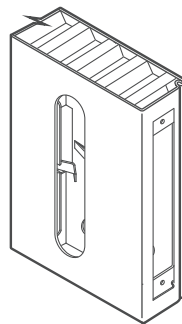

86 Lock

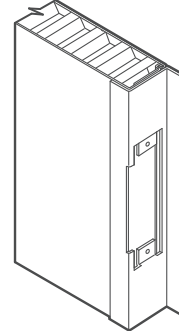

Inactive Leaf ASA Strike Prep with Astragal attached

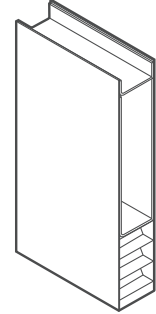

Optional 14 Gauge Closer Reinforcement

Standard: mortised and reinforced for:

- Patented Universal hinge preparations allow for easy field conversion from standard 4-1/2" (114mm) x .134" (3.3mm) standard weight hinges to 4-1/2" (114mm) x .180" (4.7mm) heavy weight hinges. Optional hinge preparation for 5" (127mm) x .146" (3.7mm) standard weight hinges or for 5" (127mm) x .190" (4.8mm) heavy weight hinges is also available.
- A multitude of standard lock preparations are available. The cylindrical 161, 61L and mortise 86 lock preps are the most commonly used active leaf preparations. The 4 7/8 (124mm) strike prep is the most commonly used inactive leaf preparation.
- Optional reinforcements for surface and concealed Closers are available.
- Special hardware applications are available.

Door Sizes and ANSI A250.8 Conversions

Steelcraft product selection for L Series doors has been matched to ANSI/SDI Level and Model designations.

- In accordance with ANSI A250.8, core material is not specific to the level or model designations. Core material selection is specified based on preference and application.
- Recommended minimum frame gauge also applies to the frequency of operation of the opening.

Series	ANSI A250.8 - SDI 100			Construction Options	Edge Maximum Sizes		Recommended Gauge of Frame
	Level	Model	Description		Single	Pair	
Level 1: Light Commercial							
L20	1	1	Full Flush	Visible	3'-0" x 8'-0" 914mm x 2438mm	6'-0" x 8'-0" 1829mm x 2438mm	18 Gauge [0.042" (1.0mm)]
LF20		2	Seamless	Epoxy Filled			16 Gauge [0.053" (1.3mm)]
Level 2: Heavy Duty Commercial & Institutional							
L18	2	1	Full Flush	Visible	4'-0" x 10'-0" 1219mm x 3048mm	8'-0" x 10'-0" 2438mm x 3048mm	16 Gauge [0.053" (1.3mm)]
LF18		2	Seamless	Epoxy Filled			
LW18		2	Seamless	Welded			
Level 3: Extra Heavy Duty Commercial & Institutional							
L16	3	1	Full Flush	Visible	4'-0" x 10'-0" 1219mm x 3048mm	8'-0" x 10'-0" 2438mm x 3048mm	16 Gauge [0.053" (1.3mm)] 14 Gauge [0.067" (1.7mm)]
LF16		2	Seamless	Epoxy Filled			
LW16		2	Seamless	Welded			
Level 4: Maximum Duty Commercial & Institutional							
L14	4	1	Full Flush	Visible	4'-0" x 10'-0" 1219mm x 3048mm	8'-0" x 10'-0" 2438mm x 3048mm	14 Gauge [0.067" (1.7mm)]
LF14		2	Seamless	Epoxy Filled			
LW14		2	Seamless	Welded			

Door edge construction

Optional Edge Seams available in the L Series doors:

- **L:** Standard feature includes visible edge seams with full height interlocked edges.
- **LF:** the mechanical edge seam is filled and finished prior to applying the factory primer.
- **LW:** the mechanical edge seam is welded and finished prior to applying the factory primer.

Standard Visible Seamless

L Series visible seam features

- Full height mechanical interlock
- Interlock filled with epoxy adhesive
- Visible edge seam

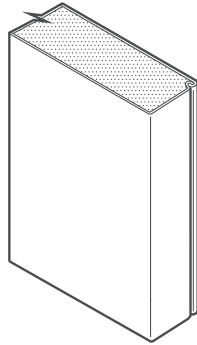

Optional Seamless Edge

LF Series Seam Filled Features

- Full height mechanical interlock
- Interlock filled with epoxy adhesive
- Edge seam is epoxy filled and finished
- No visible edge seam

LW Series Seam Welded Features

- Full height mechanical interlock
- Edge seam is welded 1" (25mm) long, 6" (152mm) on center.
- No visible edge seam

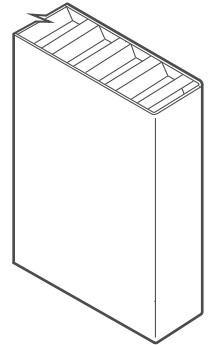

Glass light options (Refer to the Lights and Louvers section for further details and options)

Dezigner® Trim

- Standard for 1/4" Thick Glass
- Optional for 1/2" Thick Glass

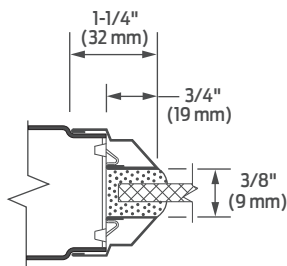

Flush Mounted Steel Trim

- For 1" Thick Glass

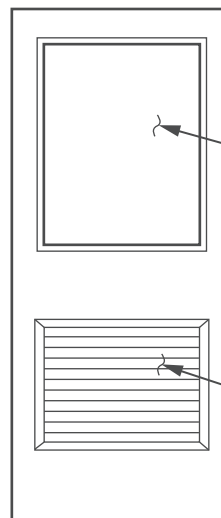
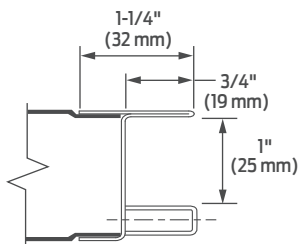

Note: Glazing type and thickness vary per job requirements.

Note: Louver size and type vary per requirements.

Divider Muntins Are Not Available